

Commonwealth of Virginia

**Technology Strategy
2023-2027**

Summer 2023





Table of Contents

- Introduction 1**
- Commonwealth of Virginia Technology Vision, Mission, Guiding Principles 2**
- Executive Summary 3**
- 2023-2027 Strategic Objectives..... 5**
 - 1 Transform the Virginian Experience.....6
 - 2 Deliver with a Commonwealth mindset.....10
 - 3 Protect Virginians through cybersecurity.....13
 - 4 Drive better, faster decision-making through data.....16
 - 5 Advance government excellence and adaptability20
 - 6 Optimize partner ecosystem23
 - 7 Cultivate statewide IT talent capability26
- Strategic Roadmap..... 30**
- Next Steps..... 31**
- Conclusion..... 32**
- References..... 33**



Introduction

The Commonwealth of Virginia Technology Strategy defines the Commonwealth's vision for technology. It communicates the Commonwealth's objectives and outlines the Commonwealth's plans for using technology to fuel growth and deliver value to Virginians.

Letter from the CIO of the Commonwealth

Governor Glenn Youngkin, Virginia's 74th Governor, has challenged all Commonwealth of Virginia agencies to make government work better. Each agency is empowered to transform to deliver higher quality services at a faster pace and with greater efficiency for the benefit of all Virginians. The drive to create irreversible positive change is led by each of the Agency Heads and Cabinet Secretaries and supported by the Office of the Chief Transformation Officer.

Technology serves the agency businesses. The agencies are the organizations that deliver value to Virginians. Technology is an enabling contributor to agency missions and business functions. Each agency has its respective mission, vision, strategy, objectives, and initiatives to achieve key performance results. This technology strategy defines the role of technology in support of the Commonwealth's agencies and defines the areas of targeted and focused technology ecosystem improvements needed to help agencies optimize their technology usage, investments, and improvements. For example, an agency may have an initiative to improve its service delivery with the role of technology being to enhance the acquisition, implementation, cybersecurity, and enablement of the technology that supports the agency's improved service delivery.

The audience for this technology strategy includes Commonwealth agencies that seek to better apply technology in their agencies; technology practitioners that seek to enhance their delivery of technology solutions; public bodies that seek to leverage Commonwealth technology best practices to improve their own organizations; and vendor partners that seek to provide technology goods, software, and services to Commonwealth buyers. The Commonwealth's agencies are addressing massive challenges including the learning loss from the global pandemic, the rebuilding of our public safety institutions (Operation Bold Blue Line)¹, regulatory reform², all-of-the-above energy policy³, and the crisis of mental health (Right Help, Right Now)⁴. Improving our technology science and art is an important part of the response to those challenges.

Robert Osmond,
Chief Information Officer of the Commonwealth



Commonwealth of Virginia Technology Vision

Trusted. Virginian-Centric. High-Performing.

Mission



Power an **innovative, resilient, and competitive** Commonwealth through high-impact technology that **enhances the lives of Virginians** and **creates a best-in-class government.**

Guiding Principles

These guiding principles define the core values underlying the Commonwealth’s purpose and use of technology to better achieve agency and business outcomes:

One Team Commonwealth

Adopt a unified and collaborative approach to technology planning that will realize greater efficiency and maximize reuse across the Commonwealth.

Virginian-Centric

Center technology planning and day-to-day delivery around the value it ultimately delivers to Virginians.

Disciplined, Innovative Delivery

Expand project/portfolio discipline and ideation capabilities to foster best practices and accelerate innovation across the Commonwealth.

Maximized Technology Value

Amplify the value of Commonwealth investments by fully leveraging technology assets across Commonwealth agencies.

Cyber Stewardship

Manage Commonwealth technology and data assets responsibly and securely for the benefit of all Virginians through top-tier cybersecurity and a common understanding that cybersecurity is a shared responsibility.

Executive Summary

Technology enables Commonwealth agencies to more effectively fulfill Virginians' needs and serves as a vehicle for continual innovation as a best-in-class government. Technology helped power the Commonwealth's resiliency, business continuity, and recovery following a global pandemic. Today, it protects the Commonwealth from cyberthreats and helps agencies deliver essential services to Virginians in increasingly digital and creative ways.

The mission of this administration is to address kitchen table issues through conservative principles to make the Commonwealth of Virginia the best place to live, work, and raise a family. Technology is an enabler of this mission, and this strategy serves as a guide to improve the delivery of technology in support of this mission.

National surveys highlight the Commonwealth's strengths in areas, such as:

- **Cybersecurity:** The Commonwealth continues to mature cybersecurity capabilities through training, vulnerability protection/remediation, expedited incident reporting, and collaborative investment.
- **Data Enablement:** The establishment of the Office of Data Governance and Analytics (ODGA) as a permanent office, the Chief Data Officer role, and the Commonwealth Data Trust (including the Open Data Portal) lay the foundation for a multi-stakeholder data exchange and analytics (including data science) platform.
- **Continuous Technology Innovations:** The Commonwealth strives to keep pace with emerging industry trends through ongoing investments, including low-code platforming, robotic process automation (RPA), and enterprise solutions.
- **Resilience:** The Commonwealth has improved its resiliency by investing in its technology infrastructure and moving data into the public/private cloud. Additional investments continue to improve business continuity and the vaulting of critical data.

Technology is constantly evolving and the Commonwealth has made important strides to keep pace through the award-winning transformation of the technology operating model and flexible service delivery through multiple service providers. While there is much to be proud of, the Commonwealth can realize more business and agency value from its technology investments and more effectively serve Virginians by breaking down operational silos, expanding reuse and best practices, and acting in a more unified way.

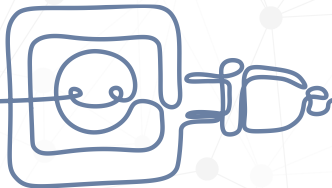



The 2023-2027 Commonwealth of Virginia (COV) Technology Strategy outlines the vision, strategic objectives, and plan for advancing technology leadership and operational effectiveness. Developed with input from Commonwealth agencies, local governments, higher education organizations, Cabinet Members, and others, it serves as the “call to action” and describes the guiding principles that must underpin collective efforts across the Commonwealth.

- **One Team Commonwealth:** The Commonwealth offers a broad range of essential services ranging from public assistance and social services to tax and revenue, licensing, public safety, and transportation. As the technology to support these mandates has expanded, so has information technology (IT) investments along operational silos and redundant spend. The Commonwealth can realize greater value for Virginians through more integrated business-technology strategic planning and execution and the reuse of core strategic platforms vs. point solutions.
- **Virginian-Centric:** Virginians need a consistent and trusted digital experience. This entails integrating agency-specific services toward Commonwealth-wide solutions. Additionally, Virginia is ranked 27th in the U.S. for broadband coverage with rural parts of the state still lacking access to high-speed internet. Investments are needed to increase access and better enable all Virginians to participate in the digital economy.
- **Disciplined, Innovative Delivery:** While the Commonwealth has improved the reliability of transactional services, it must build up capabilities and speed in delivering differentiated solutions that meet Virginians’ changing expectations. This entails advancing project/portfolio management disciplines while accelerating innovation by increasing opportunities for sharing ideas and fostering best practices across industry, academia, and the Commonwealth.
- **Maximize Technology Value:** The Commonwealth must drive greater value from its technology programs and investments and better leverage enterprise buying power with transformational Commonwealth-wide procurement processes. The Commonwealth must buy over build to speed IT delivery and maximize use of enterprise assets like ERP to improve operational efficiency and data-sharing.
- **Cyber Stewardship:** As the Commonwealth expands its digital footprint through its increased online presence and public-facing services, cyberthreats have grown exponentially. To maintain the public trust and deliver services reliably, the Commonwealth must establish shared responsibility for safeguarding Virginians by embedding security throughout the solution development life cycle and strengthening its top tier cybersecurity program. Virginia’s people and partners must optimally respond to the challenge.

This strategy describes the objectives and initiatives that support the Commonwealth’s technology vision. Each objective includes some key findings, a case for change, key strategic initiatives, and how the Commonwealth may measure progress.

These objectives are outlined to describe the value to be delivered to Virginians and internally across Commonwealth agencies and how this value will be delivered by enhancing Commonwealth capabilities related to cybersecurity, data-enablement, operational excellence and adaptability, strategic partnership, and tech talent development.

By working together to align to these objectives, the Commonwealth can achieve the vision of an innovative, resilient, and competitive Commonwealth of Virginia.



2023-2027 Strategic Objectives

-  **1 Transform the Virginian experience**
-  **2 Deliver with a Commonwealth mindset**
-  **3 Protect Virginians through cybersecurity**
-  **4 Drive better, faster decision-making through data**
-  **5 Advance government excellence and adaptability**
-  **6 Optimize partner ecosystem**
-  **7 Cultivate statewide IT talent capability**



1 Transform the Virginian experience

Overview

Technology continually changes how Virginians live, work, and prosper while also fueling the growth and competitiveness of the Commonwealth. Virginians expect a best-in-class experience interacting with the Commonwealth as they do with leading private sector organizations.

To meet these expectations, the Commonwealth will deliver responsive, digitally enabled government services that Virginians can rely on and trust. Services will be provided safely and effectively — enabling Virginians’ full participation in the digital economy.



Best-in-Class Market Trend

By 2026, governments with comprehensive strategies for improving the online experience will simplify processes by 90% while increasing public and employee satisfaction by 50%.⁷

Commonwealth Findings

Lack of comprehensive Virginian engagement strategy

The Commonwealth lacks a comprehensive strategy for engaging with Virginians to increase confidence and satisfaction with government services. Gartner research estimates that at least 85% of governments without a comprehensive customer and employee experience strategy will fail to successfully transform government services.⁵

Need for enterprise standards for digital services

While state agencies continue to individually make progress in digitizing essential services, the Commonwealth must deploy improved enterprisewide digital standards to achieve a more seamless, consistent, and trusted experience for Virginians. Websites and applications that serve the public must be standardized using common branding, cybersecurity, and services.

Comprehensive broadband coverage remains elusive

Virginia is ranked 27th in the U.S. for internet connectivity with rural parts of the state still lacking access to high-speed broadband⁶ — a barrier to digital engagement by Virginians. While Commonwealth statutes call for comprehensive broadband coverage, efforts to address gaps in coverage must be accelerated.

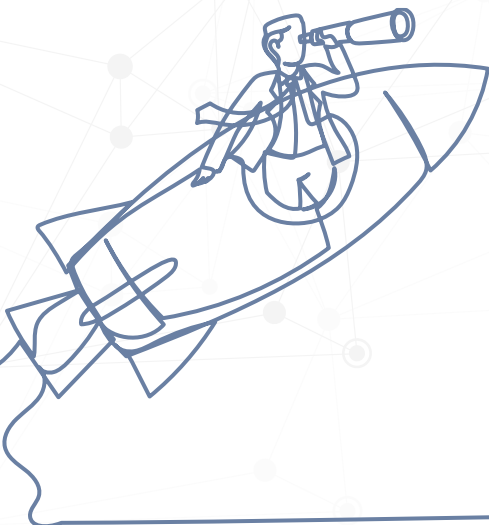



Target Outcomes

- Improved/enhanced online COV services
- Increased transactions completed through digital channels
- Compliance with security, web, and accessibility standards

- Improved satisfaction with government services
- Reduced time to completion for common processes

Strategic Initiatives

1.1 Transform and secure the online experience

Expand self-service options and ease-of-use for Virginians and government employees through a more consistent experience across digital channels and improved standards and design best practices. This will include implementing digital identity management to securely authenticate Virginians logging in to Commonwealth systems, a unified portal that can be used to access government services, and modernized Commonwealth websites with a consistent look and feel.

The Commonwealth is making progress toward improving the online customer experience by implementing standardized tools and templates to modernize agency websites, branding, and security while ensuring compliance with the Americans with Disabilities Act (ADA). The Commonwealth must continue to build on this momentum by adopting common digital solutions wherever possible and extending that work into the applications that provide digital services to Virginians.

1.2 Promote Virginian engagement and operational effectiveness

Develop and implement a comprehensive Virginian engagement strategy to develop Commonwealth services that increase convenience and value for Virginians while enabling greater operational efficiency and employee productivity/satisfaction.

This entails defining and monitoring progress through objectives and key results (OKRs) that capture the reach of services and identify areas for improvement. In partnership with state agencies, the Virginian engagement strategy will align with agency business priorities to enable a more seamless digital experience for constituents.



- Expanded broadband coverage across underserved areas
- Accessible digital skills training programs for all Virginians

1.3 Expand Commonwealth connectivity and broadband access

Increase access to safe and reliable high-speed broadband across the Commonwealth and make digital skills training available. This will better enable Virginians to thrive and prosper through participation in the digital economy.

This will be achieved by capitalizing on all available funding opportunities such as federal grants, supporting activities such as expanding the Virginia Broadband Office, developing a five-year action plan identifying Virginia's broadband needs, and evaluating emerging technologies for broadband provision.

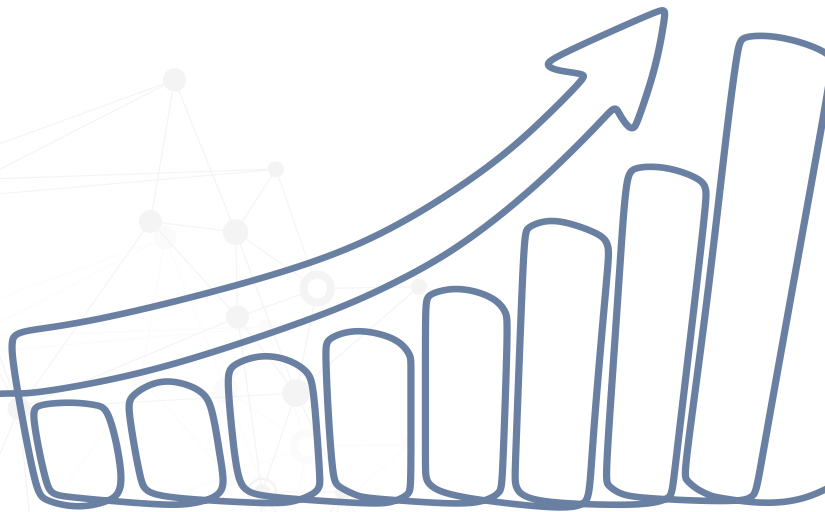



Best Practice Concept

Figure 1. Expand reach and convenience of digital public services while promoting employee effectiveness and satisfaction

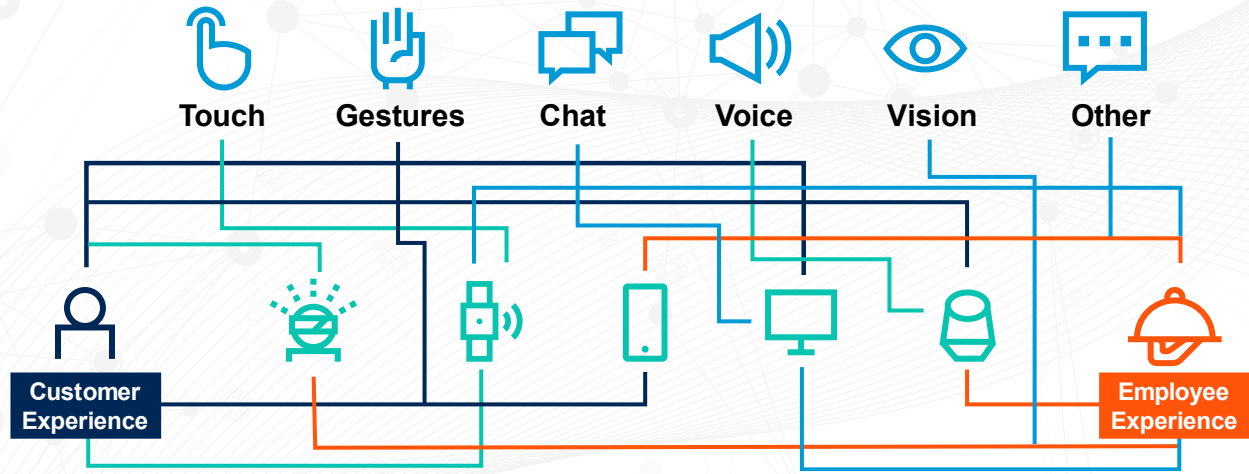

Source: Gartner

Roadmap

Strategic Objective	Strategic Initiative	2023	2024	2025
1. Transform the Virginian Experience	1.1 Transform and secure the online experience	[Progress bar spanning 2023 and 2024]		
	1.2 Promote Virginian engagement and operational effectiveness	[Progress bar spanning 2024 and 2025]		
	1.3 Expand Commonwealth connectivity and broadband access	[Progress bar spanning 2023, 2024, and 2025]		



2 Deliver with a Commonwealth mindset

Overview

The Commonwealth works tirelessly to deliver a broad range of essential services that enhance the lives of Virginia’s residents, businesses, visitors, and other stakeholders. These services range from public assistance and social services to tax and revenue, licensing, public safety, and transportation. As the Commonwealth evolves rapidly to expedite these services and improve the experience for Virginians, redundant spend on similar technologies has emerged as a side effect that needs remediation. While the Commonwealth will continue to keep pace with the everchanging technological environment, investment in these technologies will be done more strategically to achieve stronger economies of scale, cost savings, and operational efficiency.

The goal is to promote a Commonwealth mindset that enables an integrated approach to technology planning and investment by business and technology leaders. A unified and collaborative approach will realize greater efficiency, maximize reuse, reduce redundant spend, and improve cost savings across the Commonwealth.



Best-in-Class Market Trend

Enterprises should have only one strategy — the business strategy — IT must be a core part of it... embedding technology directly in the business strategy.⁸

Commonwealth Findings

Technology investments must serve a business priority

Technology investment is primarily supported by operational decision-making at the agency level. Agency business strategies are not consistently aligned with technology decisions, hindering an enterprise approach that would help reduce redundant spending and enable improved technology investment. This strategic plan must serve as a catalyst toward unified business and technology plans for the future of the Commonwealth.

Historical spend on point solutions vs. enterprise platforms

The Commonwealth’s shared application landscape totals over 2,500 active applications. The high number of specialized applications increases risk, drains resources, and prohibits a more strategic, sustainable approach to business capability delivery. Investments need to shift from point solutions to shared and enterprise solutions to consolidate and reduce duplicative costs.



Target Outcomes

- Integrated and streamlined IT Strategic Planning (ITSP) process

- Increased agency cloud adoption
- Increased IT return on investment

- Reduction of point solutions

Strategic Initiatives

2.1 Integrate business-technology strategic planning

Leverage the existing Commonwealth technology strategy as the catalyst for establishing a streamlined strategic planning approach that better articulates agencies’ business priorities and addresses them through enterprise solutions and communities of practice.

Establishing and documenting integrated business and technology strategic plans at the agency and Commonwealth levels will ground IT investment decisions and guide how future technology will work to support business goals and objectives.

2.2 Promote operational efficiency through shared infrastructure

Promote state agency adoption of centralized infrastructure services (public cloud, server storage, end-user compute, cybersecurity, print, network) through transparent and tangible value propositions and clear metrics as to what centralized services are already being adopted by stakeholders, and how those services are producing measurable outcomes such as improved service quality or increased service velocity.

The Commonwealth has already established the Enterprise Cloud Oversight Service (ECOS) to promote compliance and improve security. Aligning with ECOS allows agencies to gain increased flexibility while enabling data protection, proper utilization of resources, compliance with regulations and laws, and timely resolution of audit recommendations.

2.3 Expand reuse and consolidate Commonwealth shared applications through Enterprise Architecture

Consolidate redundant/duplicative applications into higher utility solutions by maturing the Enterprise Architecture (EA) capability. A collaborative enterprise architecture approach will optimize return on investment by evaluating financial and business justifications when establishing or renewing IT contracts. Progress on this goal will reduce the number of duplicative applications as well as help the Commonwealth save on IT costs and improve solution velocity through enterprise approaches like low code/no code solutions.

Best Practice Concept

Identify useful, reusable components (Packaged Business Capabilities (PBCs)) that represent common business functions. PBCs can be used as building blocks to develop composable applications, promote reusability, advance enterprise architecture capabilities, and reduce duplicative spend.

Figure 2. Reference model for composable business applications

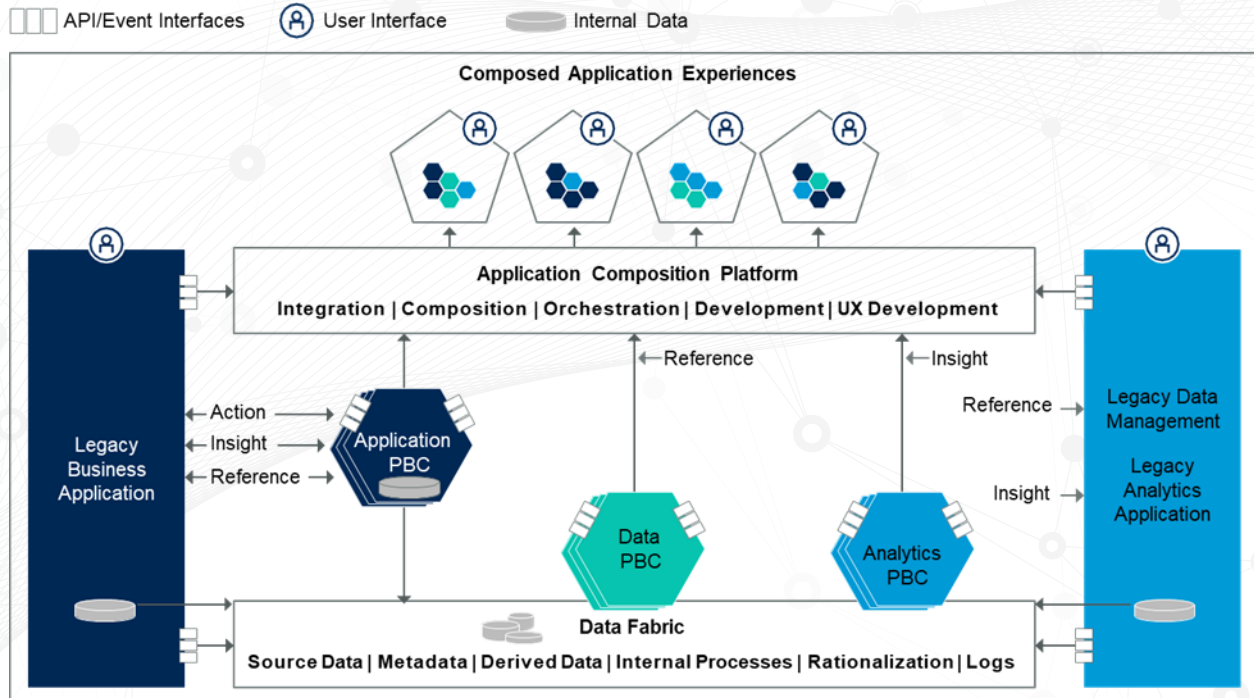

Source: Gartner

Roadmap

Strategic Objective	Strategic Initiative	2023	2024	2025
2. Deliver with a Commonwealth mindset	2.1 Integrate business-technology strategic planning	[Progress bar spanning 2023 and 2024]		
	2.2 Promote operational efficiency through shared infrastructure	[Progress bar spanning 2023 and 2024]		
	2.3 Expand reuse and consolidate Commonwealth shared apps through EA	[Progress bar spanning 2024 and 2025]		



3 Protect Virginians through cybersecurity

Overview

In 2022, the Virginia General Assembly approved legislation to establish a Commonwealth-wide approach for addressing threats and protecting Virginia’s assets and data. Through a best-in-class, comprehensive cybersecurity program, the Commonwealth will secure and maintain public trust and create a culture of shared responsibility for cybersecurity.

To achieve this, Commonwealth agencies, localities, public and private partners must work collaboratively to drive technology solutions that safeguard the enterprise environment.



**Best-in-Class
Market Trend**

Historically, government organizations addressed cybersecurity in terms of compliance with volumes of written artifacts... governments are shifting from compliance-based to risk-based approaches as the complexity of threats and vulnerabilities increases.¹¹

Commonwealth Findings

Threat expansion

As the Commonwealth expands its digital footprint and public-facing services, the attack surface inevitably expands. Also, with an average of two to three new cloud applications being added per week, more applications will need to be secured. Proactively addressing these threats will require ongoing investment in security tools as well as developing architectural approaches and an organizational mindset where cybersecurity is embedded throughout the Commonwealth.

Compliance gaps

Commonwealth of Virginia Single Audit Report for The Year Ended June 30, 2022, identified delays in conducting required IT security audits for sensitive systems, gaps in agency security standards, and cases of IT service providers not being held accountable for security requirements in their contracts.⁹

Increased cyber attacks

The rate of cyber attacks is increasing and malicious actors are becoming more sophisticated. Recent research on cyberattack trends cites a 38% increase in global attacks in 2022 compared to 2021.¹⁰ The Commonwealth responds to over 30 million cyberattack attempts and blocks more than half a million pieces of malware on the Commonwealth’s network every year.



Target Outcomes

- Improved resistance to cyberattack
- Implemented Zero Trust security strategy

- Increased employee participation in security training
- Accelerated incident reporting and vulnerability remediation
- Secured backups to combat ransomware

- Improved collaboration with cybersecurity partners
- Compliance with security requirements
- Protection of Virginian privacy

Strategic Initiatives

3.1 Fortify cybersecurity (Zero Trust)

While the Commonwealth already demonstrates extensive security practices, policies, and procedures, it will continue to proactively advance a “Zero-Trust” model for identity and access management and stand up the necessary technology.

The Commonwealth will continue to scale, mature, and deploy cybersecurity processes to bring protective technologies closer to sensitive systems and data.

3.2 Embed and advance cybersecurity

Continue to deliver a top-tier cybersecurity program that provides cybersecurity training, accelerates vulnerability remediation, and promotes a culture of shared responsibility for safeguarding Virginians.

The Commonwealth will advance current cybersecurity practices by expediting incident reporting and response, increasing the protection of backups to combat ransomware, and expanding the adoption of enhanced multi-factor authentication.

3.3 Extend enterprise cybersecurity and privacy best practices

Use a whole-of-state approach to share cybersecurity best practices, protect Virginian privacy, and promote collaboration and engagement throughout the Commonwealth.

The Commonwealth will extend current security and privacy practices through the federal cybersecurity grant program by working with state and local partners and integrating with the Virginia Fusion Center. The Commonwealth will expand current trainings and provide additional training opportunities including specialized training for agency chief information security officers (CISOs). Centrally provided training will help establish a cybersecurity baseline with opportunities for more tailored, additional trainings to ensure that all needs can be met while reducing strain on agencies to establish their own programs.



Best Practice Concept

Zero Trust architecture improves cyberthreat defense by ensuring only appropriate access is provided to verified users.

Figure 3. High-level Zero Trust system

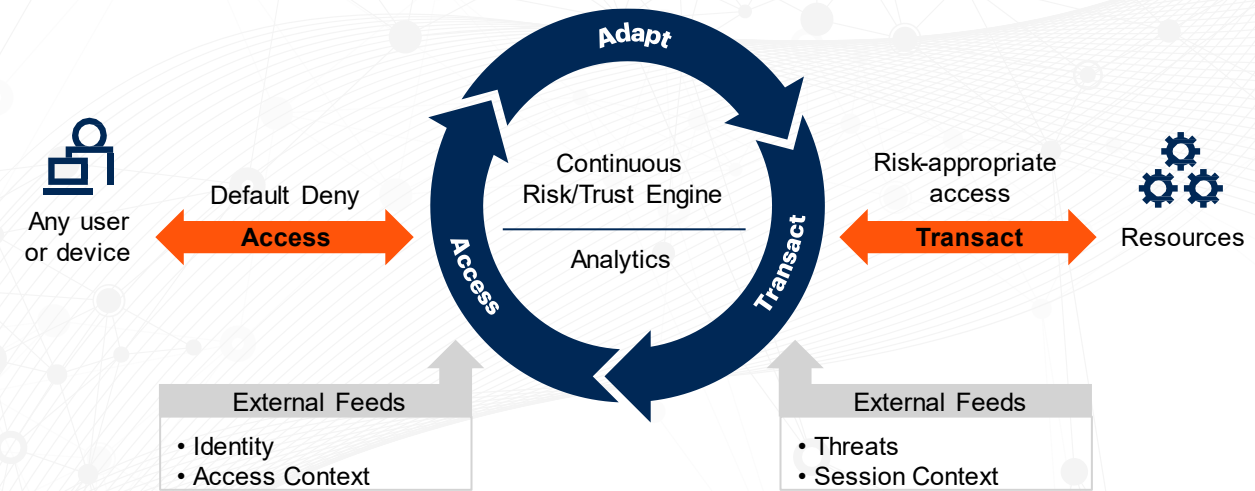

Source: Gartner

Roadmap

Strategic Objective	Strategic Initiative	2023	2024	2025
3. Protect Virginians through Cybersecurity	3.1 Fortify cybersecurity (Zero Trust)	[Progress bar spanning 2023 and 2024]		
	3.2 Embed and advance cybersecurity	[Progress bar spanning 2024 and 2025]		
	3.3 Extend enterprise cybersecurity best practices	[Progress bar spanning 2024 and 2025]		



4 Drive better, faster decision-making through data

Overview

A data-driven Commonwealth will harness the power of data to make informed and timely decisions through accurate and up-to-date information. Data and analytics are essential to improving transparency and accountability, enabling a seamless digital experience for Virginians, and proactively enhancing quality of life across the Commonwealth. For example, predictive analytics can be used to advance mission-critical initiatives such as “Right Help, Right Now” to preemptively support at-risk individuals.

To achieve these aspirations, the Commonwealth will implement best practices to promote data-sharing, expand data and analytics expertise, and better leverage existing resources such as the Office of Data Governance and Analytics (ODGA).



Best-in-Class Market Trend

By 2024, 60% of government AI and data analytics investments will directly impact real-time operational decisions and outcomes.¹²

Commonwealth Findings

Need for clear strategic direction and governance for Commonwealth data

The Commonwealth has vast amounts of data that are sub-optimally leveraged to improve operations and Virginian services. While ODGA has communicated a strategic vision for improving data sharing, quality, and capabilities, it has not yet been fully adopted across the Commonwealth. Broader data sharing will work to improve the provision of services and outcomes and expand the opportunities for data-driven decision-making.

Need to incentivize agencies to contribute to the Data Trust

The current Data Trust owned by ODGA has onboarded 42 agencies, localities, and organizations and 1,255 datasets. While there is no mandate to join the Commonwealth Data Trust, agencies can gain several benefits by becoming members. Members of the trust engage in secure, safe data sharing through onboarding to the ODGA Azure environment. This environment uses standard National Information Exchange Model (NIEM) protocols.

The Data Trust ensures and supports data discovery and analytics for agencies and organizations across the Commonwealth of Virginia. ODGA acts as the conduit for data sharing, receiving requests for Commonwealth Data Trust agency data and fulfilling those requests on behalf of the agency. ODGA also provides a variety of services to Commonwealth Data Trust members, including, but not limited to data storage, data sharing, data analysis, data dashboard visualizations, and data automation. In addition, ODGA provides Dataversity training that

increases data governance literacy exclusively to Commonwealth Data Trust members at no cost to their respective agencies.

Lack of enterprise standards and tools for data analytics

An enterprise data policy, standards document, and toolset does not exist. With significant recent innovations in data science (including artificial intelligence and machine learning), more is needed to support innovations and exploit new commercial capabilities. Creating a standardized data operating model with provide a common technological baseline and establish a strong foundation that stakeholders can use to accelerate their data programs.





Target Outcomes

- Better, more timely data
- Increased data and analytics training opportunities

- Expanded agency enrollment in Data Trust
- Increased number of datasets in Data Trust

- Increased Data Trust utilization
- Introduced artificial intelligence

Strategic Initiatives

4.1 Drive timely, data-driven decision-making

Enable agencies to make more data-informed decisions through standardized data and analytics tools, Commonwealth-wide data literacy, and enterprise capabilities.

ODGA will continue efforts to position data and analytics as a business function by helping agencies link data initiatives to their own business objectives. Understanding these business uses and relevant key performance indicators (KPIs) and creating data reporting and visualizations to monitor progress against these important indicators will provide agencies with the most pertinent information they need to make decisions and monitor progress against their goals. The Commonwealth will also mature the level of data literacy through initiatives such as training to agencies on best practices for collecting and interpreting data and improving data quality/accuracy.

4.2 Establish data exchange and enterprise platforms

Provide compelling incentives and a secure means for data-sharing across the Commonwealth to enable cross-department analyses and centralized sources of information for Virginians. Establish and govern data-sharing to ensure data privacy for Virginians and improve data quality and accuracy. Provision cloud data platforms to agencies.

While the Commonwealth has already established a technology environment to support the sharing of data, a culture of data-sharing can expedite progress by promoting effective, measurable sharing of data among state, regional, and local institutions.

4.3 Optimize data assets and resources

Support ODGA outreach efforts to increase agencies' participation in the Commonwealth data trust and use of enterprise capabilities and resources for data analytics and data science (including artificial intelligence and machine learning).

Agency adoption of the emerging ODGA governance framework and establishment of an Executive Data Board (EDB) and Data Governance Council (DGC) will help build consensus and business buy in for data governance and use of the Data Trust.



Best Practice Concept
Figure 4. Approach for incrementally improving data & analytics capability

Enable, Expand and Evolve Analytics

■ Enable
 ■ Expand
 ■ Evolve

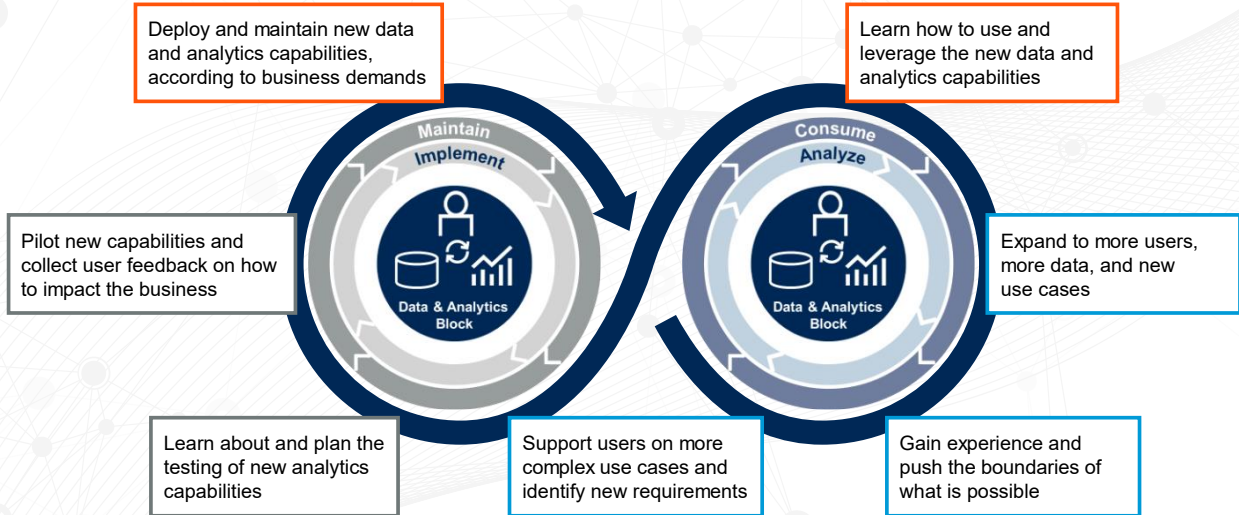

Source: Gartner

Roadmap

Strategic Objective	Strategic Initiative	2023	2024	2025
4. Drive better, faster decision making through data	4.1 Drive timely, data-driven decision-making	[Bar chart showing activity from 2023 to 2024]		
	4.2 Establish data exchange & enterprise platforms	[Bar chart showing activity from 2024 to 2025]		
	4.3 Optimize data assets and resources	[Bar chart showing activity from 2024 to 2025]		



5 Advance government excellence and adaptability

Overview

Commonwealth-wide governance promotes accountability, transparency, and efficiency across agencies and service providers by establishing the necessary controls to minimize redundant IT spend and guarantee proper stewardship of Commonwealth resources. To assure necessary controls and accountability while minimizing bureaucracy, the Commonwealth will implement and better automate a progressive governance model that rightsizes processes to enable agencies to spend more time serving Virginians.

Realizing government excellence will require all state agencies and partners to effectively manage and adapt to change. The Commonwealth will build upon the organizational change management program established by the Virginia IT Agency (VITA) to encourage an increased focus on the people side of change. This will lead to improved results by further capturing the people dependent return on investment (speed of adoption, ultimate utilization, and proficiency).



Best-in-Class Market Trend

Using technology to change in the way in which government achieves outcomes is not a technology problem for IT to solve, both business and technology leaders are needed to design, execute, and enforce change in how government delivers outcomes.¹³

Commonwealth Findings

Rigorous, but document-intensive governance

While the governance process is comprehensive with careful thought given to each compliance requirement, the fast pace of technology advances and changing Virginian expectations mandates more flexibility to adapt to wide-ranging needs and complexities across state agencies than what the current model provides. This entails reviewing and optimizing key governance triggers/thresholds to provide sufficient controls and oversight while accommodating increasing costs for IT solutions.

Governance complexities related to multisupplier delivery model

While the multisupplier delivery model expands technology capabilities, governance becomes more complex as accountability and hand-offs are distributed across multiple service providers creating bottlenecks and unclear resolutions at times.

Operational silos

In the current state, many technology decisions are being made at the operational level, which at times may result in redundancies, inefficiencies, or missed collaboration opportunities. A strong organizational change management program will foster an enterprise-first mindset and will help reduce operational silos.



Target Outcomes

- Increased First Contact Resolutions (FCR) and Mean Time to Restore (MTTR)
- Increased time recaptured through automation

- Accelerated procurement cycle time
- Optimized procurement value

- Improved service value feedback and service adoption
- Increased Commonwealth change management maturity level

Strategic Initiatives

5.1 Streamline internal processes to improve operational efficiency and transparency

Simplify governance by scaling and automating processes to support varying levels of complexity and promote transparency across multi-party service hand-offs and approvals.

The Commonwealth will implement and better automate a progressive governance model that rightsizes processes to enable agencies to spend more time serving Virginians. To boost operational efficiency and transparency, the Commonwealth will work to improve and accelerate high-risk contract review by increasing agency engagement and communication.

5.2 Consolidate procurement processes

Streamline procurement processes to eliminate redundant steps, reduce procurement cycle time, and optimize procurement value.

The Commonwealth has initiated a review of technology procurement processes to identify opportunities for decreasing procurement time, improving efficiency, and making it easier for agencies to navigate. The next step is to prioritize and implement improvements through collaboration across VITA, the Governor’s Office, and state agencies.

5.3 Scale and deploy organizational change management (OCM) capability

Build upon the VITA OCM initiative to establish a comprehensive program to promote a customer/Virginian-centric culture and the openness to change needed to keep pace with evolving technologies and business priorities.

This OCM capability will include channels that promote two-way communication to keep Commonwealth entities connected and committed, a change agent network (e.g., customer account managers, business relationship managers, state agency representatives, etc.) to help eliminate siloed decision-making and promote transparency, and a leadership team and governance model to manage change and monitor success measures.



Best Practice Concept

Figure 5. Progressive governance model and OCM integration

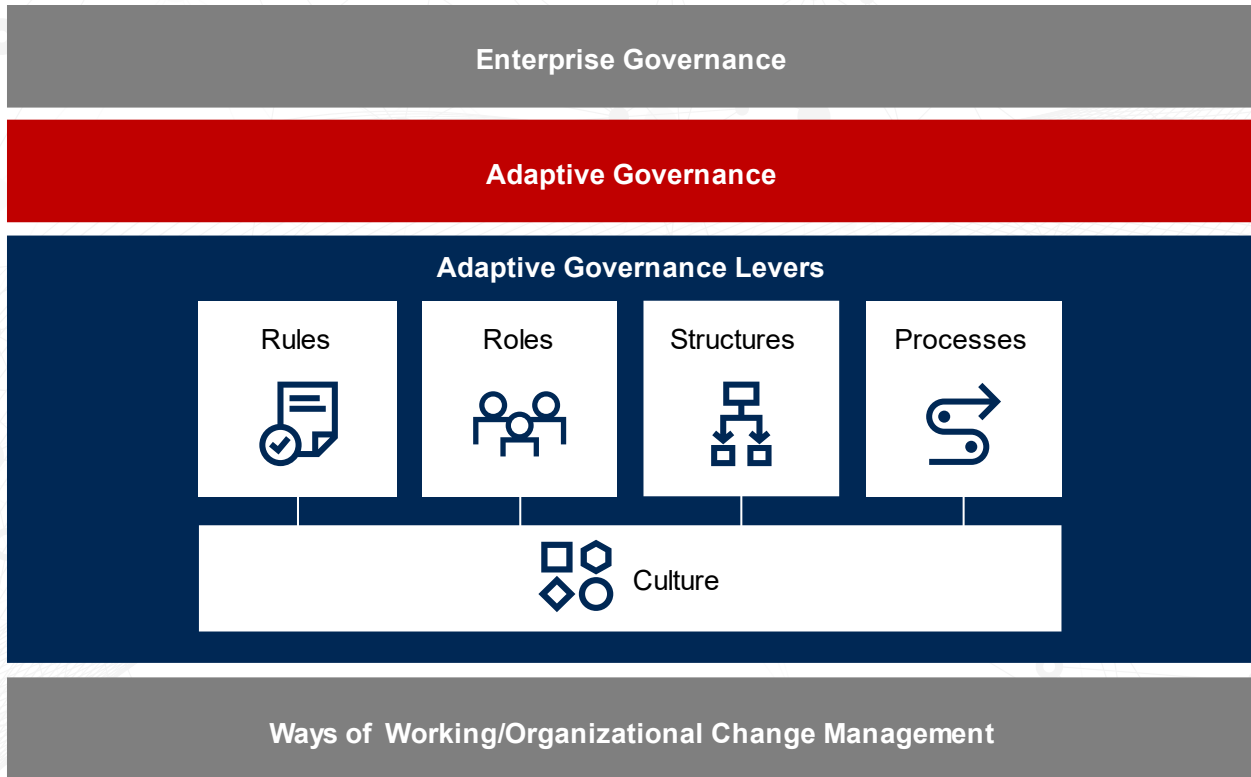

Source: Gartner

Roadmap

Strategic Objective	Strategic Initiative	2023	2024	2025
5. Advance government excellence and adaptability	5.1 Streamline internal processes to improve operational efficiency and transparency	[Progress bar spanning 2023 and 2024]		
	5.2 Consolidate procurement processes	[Progress bar spanning 2023, 2024, and 2025]		
	5.3 Scale and deploy organizational change management (OCM) capability	[Progress bar spanning 2023, 2024, and 2025]		



6 Optimize partner ecosystem

Overview

The Commonwealth’s technology services are provided across multiple service providers and contracts. This approach enables greater service delivery flexibility and innovation, improves economies of scale, and expands opportunities for cost savings through multiple vendor contracts.

Global spend on external vendors accounts for 64% of IT spend and continues to grow 1 to 2% annually, underscoring the importance of a strong vendor management capability. This objective will to both strengthen the productivity of current outsourcing arrangements and expand the Commonwealth’s partner ecosystem (including educational institutions, private sector, etc.) to broaden access to emerging technology and know-how.



**Best-in-Class
Market Trend**

By 2025, business-outcome-based SLAs will be the predominant success measure of outsourced relationships, rising from 15% in 2021 to over 70%.¹⁴

Commonwealth Findings

Opportunity to improve end-to-end vendor management

While the broad partner ecosystem has afforded the Commonwealth a variety of services, the hand-offs across suppliers can lead to service delays and less clear accountability. The Commonwealth must consider outcome-based agreements, operating level agreements (OLAs), and creating incentives for vendors to work together to drive more favorable results. This entails moving away from traditional service-level agreements (SLAs), which are increasingly obsolete as standards of overall performance increase.

Need for agile partnerships to enable innovation

Service delivery by Commonwealth technology providers have historically been most effective in delivering mature technology services. As the pace of technology continues to accelerate, the Commonwealth must mature its capabilities for delivering on less standard services and incorporating technology innovations as part of normal operations. Additionally, establishing a structured approach for innovation will enable collaborations with external partners to achieve more productive, measurable results.

Lack of enterprise procurement application ecosystem

The Commonwealth lacks an enterprise Procure-to-Pay (P2P) capability with procurement functions currently distributed among agencies and various applications. This hinders procurement optimization leading to missed saving opportunities.



Target Outcomes

- Improved vendor performance metrics
- Increased number of successful standard platform onboarding
- Increased low-code capabilities

- Increased innovation opportunities
- New forums for idea sharing across the Commonwealth
- Accelerated robotic process automation deployments

Strategic Initiatives

6.1 Optimize partner ecosystem

Realize increased value from Commonwealth partnerships by improving project delivery capabilities for innovative solutions and optimizing processes (e.g., costing, resourcing, performance management).

While the Commonwealth's partner ecosystem stands solid today, this objective will focus on expanding shared services, technologies, and learnings across a broader range of organizations — for example, providing localities and educational institutions increased opportunities to benefit from statewide technology contracts and participate in statewide data-sharing.

This objective will also maximize the value the Commonwealth receives from technology providers and enhance accountability through improved vendor management practices such as increased incentives and penalties to drive better vendor performance. The Commonwealth will also build the right contractual elements to foster quality delivery for stakeholders. Metrics for improved performance measurement and reporting will be derived from business goals and used to monitor the experience of end-users as well as supplier-driven innovation.

6.2 Expand capabilities and opportunities for innovation and cost savings

Tune the partner model to drive innovation through proactive sharing/implementation of new ideas, solutions, and approaches that improve Virginian-facing services and IT delivery.

To promote opportunities for innovation, the Commonwealth will work to encourage agencies to deploy robotic automations, improve application integration and develop low-code capabilities. The Commonwealth will also increase opportunities for ideation/experimentation through avenues such as vendor forums, consortiums, and pilots. To enhance procurement capabilities, the Commonwealth will simplify and integrate supporting applications and automate and integrate the transactional flow between procurement applications by developing and executing on a consolidation strategy.



Best Practice Concept

Figure 6. The Commonwealth will harness ideas from a broad range of partners to build a sustainable innovation program



Outputs

- Compelling, Valuable Virginian Services
- Accelerated Innovation
- Strengthened Thought Leadership
- Improved Collaboration & Data-Sharing
- Economies of Scale
- Optimized Buying Power
- Expanded Tech Talent Pipeline

Source: Gartner

Roadmap

Strategic Objective	Strategic Initiative	2023	2024	2025
6. Optimize partner ecosystem	6.1 Optimize partner ecosystem	█		
	6.2 Expand capabilities and opportunities for innovation and cost savings	█		



7 Cultivate statewide IT talent capability

Overview

A high-performing technology workforce is essential to the Commonwealth. While government needs to recruit and develop technology talent to achieve strategic priorities, the Commonwealth also needs to ensure that all Virginians have the opportunity to develop the technology skills needed to succeed now and in the future.

This objective will empower and inspire the current workforce while developing a pipeline of future talent through increased collaboration, investment, and engagement.



Best-in-Class Market Trend

This talent crunch can be attributed to the growing post pandemic digital transformation investment, which has pushed the demand for digital talent far past its supply. We believe this talent crunch will last at least two years, perhaps significantly longer for some niche and critical skills. Thus, IT leaders must plan for both short-term and long-term talent management and sourcing strategies for each type of digital talent required.¹⁸

Commonwealth Findings

Demand for IT talent outstrips supply

At the time of this plan, the Commonwealth currently has 300+ of its government IT positions vacant. Across the public and private sectors, 20,000+ tech jobs were posted in March 2023¹⁵. Despite the Commonwealth having among the highest concentration of tech industry workers,¹⁶ these vacancies represent unmet demand.

Lack of centralized training delivery

Current training services for Commonwealth IT roles are siloed among agencies and organizations which can lead to inconsistent, resource-consuming learnings and duplicative capabilities. Given the already limited IT resources across agencies and localities, it is difficult to take time and personnel to conduct comprehensive training — particularly with increased employee turnover. In a recent national survey of public-sector employees, lack of career development opportunities was the top reason for leaving.¹⁷

Underleveraged innovation resources

Virginia is home to 80+ higher education institutions and 20+ Fortune 500 company headquarters. The Commonwealth can do more to tap into these resources to accelerate the pace of innovation, improve returns on technology investments, and increase satisfaction/motivation of Commonwealth technologists.



Target Outcomes

- Increased number of established development programs
- Improved career advancement opportunities for commonwealth IT employees
- Reduced turnover

- Increased IT educational opportunities for Virginians

Strategic Initiatives

7.1 Refresh and promote IT careers

Develop and support Commonwealth IT employees through recruitment, engagement, and professional development that empowers employees to grow their capabilities and take ownership in advancing their careers as Virginia technologists with a passion for serving their Commonwealth.

The Commonwealth will develop IT career paths that provide Commonwealth IT employees a framework to advance their careers and define training and development opportunities including common training curricula and opportunities for Commonwealth IT staff to lead trainings. This initiative will also expand partnerships across schools, universities, agencies, and localities to recruit for key roles and augment the use of data and analytics to identify and recruit top candidates.

7.2 Develop a tech-ready workforce

Promote collaborations across Commonwealth agencies, localities, educational institutions, and the private sector to spread excitement, knowledge and opportunities for the next generation technology leaders, up-skill the current workforce, and attract businesses to the Commonwealth.

The Commonwealth will expand on initiatives focused on Virginia’s youth that are already underway, such as student hackathons, contests and training programs including Cyber Range and the Tech Talent Investment Program and create additional investments in science, technology, engineering and mathematics (STEM) programming, apprenticeships, and mentoring opportunities to cultivate a pipeline of technology talent. The Commonwealth will also augment programs for all Virginians that provide training, job placement, and learning opportunities specifically geared toward providing the skills and resources needed to secure technology jobs.

Boosting the availability of skilled technology will further spur employment growth and attract companies in search of talent to the Commonwealth.



- Increased collaboration across the commonwealth

7.3 Expand technology thought leadership and innovation

Establish forums to share industry trends and best practices, promote reuse/repeatable processes, and enable continuous innovation. For example, the Commonwealth will scale and expand already established Centers of Excellence focused on robotic process automation and common tools and incorporate into the Commonwealth's ways of working.



Best Practice Concept

Figure 7. Five levers for COV to meet the tech talent shortage

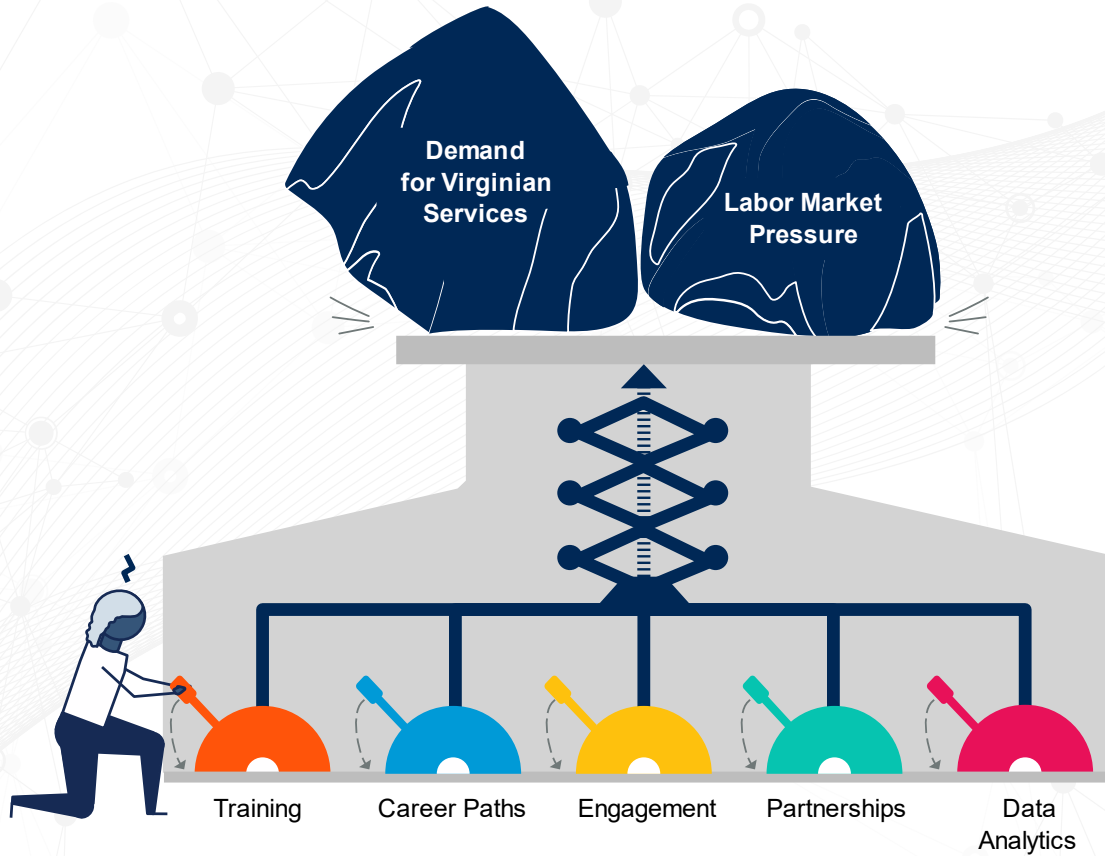

Source: Gartner

Roadmap

Strategic Objective	Strategic Initiative	2023	2024	2025
7. Cultivate statewide IT talent capability	7.1 Refresh and promote Commonwealth IT careers	[Progress bar]		
	7.2 Develop a tech-ready workforce	[Progress bar]		
	7.3 Expand thought leadership and innovation	[Progress bar]		



Strategic Roadmap

Strategic Objective	Strategic Initiative	2023	2024	2025
1. Transform the Virginian Experience	1.1 Transform and secure the online experience	██████████		
	1.2 Promote Virginian engagement and operational effectiveness		██████████	
	1.3 Expand Commonwealth connectivity and broadband access	██████████		
2. Deliver with a Commonwealth mindset	2.1 Integrate business-technology strategic planning	██████████		
	2.2 Promote operational efficiency through shared infrastructure	██████████		
	2.3 Expand reuse and consolidate Commonwealth shared apps through EA		██████████	
3. Protect Virginians through Cybersecurity	3.1 Fortify cybersecurity (Zero Trust)	██████████		
	3.2 Embed and advance cybersecurity		██████████	
	3.3 Extend enterprise cybersecurity best practices		██████████	
4. Drive better, faster decision making through data	4.1 Drive timely, data-driven decision-making	██████████		
	4.2 Establish data exchange & enterprise platforms		██████████	
	4.3 Optimize data assets and resources		██████████	
5. Advance government excellence and adaptability	5.1 Streamline internal processes to improve operational efficiency and transparency	██████████		
	5.2 Consolidate procurement processes	██████████		
	5.3 Scale and deploy organizational change management (OCM) capability	██████████		
6. Optimize partner ecosystem	6.1 Optimize partner ecosystem	██████████		
	6.2 Expand capabilities and opportunities for innovation and cost savings	██████████		
7. Cultivate statewide IT talent capability	7.1 Refresh and promote Commonwealth IT careers	██████████		
	7.2 Develop a tech-ready workforce	██████████		
	7.3 Expand thought leadership and innovation	██████████		

Next Steps

We have a shared responsibility to ensure that technology is harnessed to achieve our vision of an innovative, resilient, and competitive Commonwealth that enhances the lives of Virginians and creates a best-in-class government.

Going forward, the Commonwealth of Virginia Technology Strategy will inspire and be integrated with technology planning done at various levels throughout the Commonwealth.

Figure 8. COV Strategic Planning



Commonwealth of Virginia IT Strategy

- Defines the Commonwealth’s vision for technology and drives strategic decision-making. It communicates the Commonwealth’s objectives for using technology to fuel growth and sustainability and deliver value to Virginians.

VITA Strategic Business Plan

- Describes the action plan for how VITA and State Agencies will realize the Commonwealth’s vision for technology. Identifies the roadmap of initiatives, key standards, and the target architecture and operating model.

State Agencies’ Business & Technology Strategies

- Articulates the initiatives required to deliver citizen-facing services and day-to-day operational functions at the agency level. Usually closely related to the budget process.

Source: Gartner

To operationalize this strategy, the Office of the CIO of the Commonwealth will:

- Share the plan with Commonwealth agencies, partners, and other stakeholders to facilitate an enterprisewide understanding and buy-in of key outcomes, responsibilities, and timelines.
- Define the specific actions and resources to support the strategic initiatives and identify leadership roles to implement action steps.
- Empower the CIO Advisory Council (CAC), with participants from Commonwealth agencies, with regularly reviewing the plan, measuring progress against strategic goals, and presenting results.



Conclusion

The success of this plan will require active participation from Commonwealth leaders and partners in both the public and private sectors, as well as dedication to technology advancement.

Through the objectives and initiatives outlined in this plan, the Commonwealth will serve as an example for how technology can be used to create a best-in-class government and further innovation, resiliency, and economic development. These efforts will produce Virginian-centered technology solutions that are accessible to all and achieve impactful results for state agencies and Commonwealth stakeholders.



Outcomes for Virginians

- Protected privacy
- Expanded self-service options
- Transparency
- Ease of doing business
- Data-driven policies



Impact for Agencies and other Commonwealth Organizations

- Agile governance
- Streamlined procurement
- Improved access to data
- Reliable service
- Safeguard assets & data
- Cost savings
- Streamlined processes
- Enhanced collaboration



Improvements to IT Operating Model

- Vendor management
- Policies, standards and governance
- Training
- Partner ecosystem
- Procurement rules
- Cybersecurity



References

- 1 [Governor Glenn Youngkin Unveils Operation Bold Blue Line](#). Office of the Governor.
- 2 [Governor Glenn Youngkin Issues Executive Order Reforming Virginia's Regulatory Process](#). Office of the Governor.
- 3 [Governor Glenn Youngkin Releases Virginia's Energy Plan](#). Office of the Governor.
- 4 [Right Help, Right Now: A Transformational Behavioral Health Plan for Virginians](#). Virginia Health and Human Resources.
- 5 Kaushik et al. (2022, January 18). [Top Trends in Government for 2022: Total Experience](#). Gartner.
- 6 [Va. To receive \\$6.22M to expand broadband](#), Virginia Business
- 7 Mickoleit et al. (2023, February 27). [Top Technology Trends in Government 2023](#), Gartner.
- 8 Cox et al. (2021, January 28). IT Strategy Toolkit – Embedding Information and Technology in Business Strategy. Gartner.
- 9 [Commonwealth of Virginia Single Audit Report For the Year Ended June 30, 2022](#). Virginia Auditor of Public Accounts.
- 10 [2023 Cybersecurity Report](#). Checkpoint Research.
- 11 Brown et al. (2023, March 3) Top Trends in Government: Adaptive Security. Gartner
- 12 Mickoleit et al. (2022, 18 January) [Top Technology Trends in Government for 2022](#). Gartner.
- 13 Kost J. (2022, October 14) Leadership is Critical to Achieving Digital Success in Government. Gartner.
- 14 Gove et al. (2023, January 24) Market Opportunity Map: IT Services, Worldwide. Gartner.
- 15 [The Tech Jobs Report](#). CompTIA.
- 16 [Cyberstates 2023 Report](#). CompTIA.
- 17 [What workers want is changing. That could be good for government](#). McKinsey.
- 18 Stanley et al. (2021, September 21) How to Address and Plan for the Increasingly Severe IT Talent Shortage?. Gartner.

